



# Exterior Shading Systems by Crown



**Crown Shade Company**  
crownshade.com / baltimore, maryland





## Maximizing Outdoor Living

Exterior shades provide insect protection, wind protection and UV protection - all while allowing crisp views through to the outdoors.



## Increasing Indoor Comfort & Efficiency

Screen shades mounted on the outside of a building's glazing system are designed to notably reduce solar load and promote optimal indoor climate. UV rays are blocked before making contact with the building envelope, which can dramatically reduce air conditioning energy costs in the summer months. Exterior screens also provide complete glare protection while preserving exterior views.

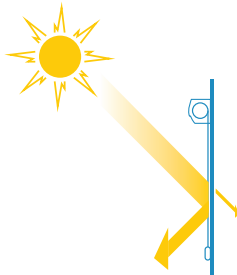
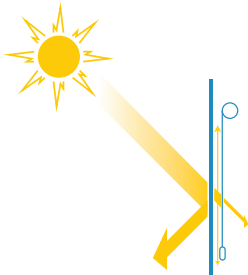

### Lift System Options

110v AC, low voltage and new solar powered motors are available. We offer brands such as Somfy, Goposa, NICE and Rollease Automate. A manual crank solution is available for shades under 144 sq.ft.

### Head Box Options

We offer front loading clamshell head boxes in 2 sizes as well as a unique flush box option for fully recessed, bottom loading installations. See page 7 for more details.



Officially tested to withstand up to 80 mph winds!

Up to 20 ft Wide

### ZipTrack Hem Bars

ZipTrack hem bars are engineered to withstand 80+\* mph winds when installed with our ZipTrack side channels. They weigh approximately 3 lbs per foot, clocking in at the heaviest in the industry.

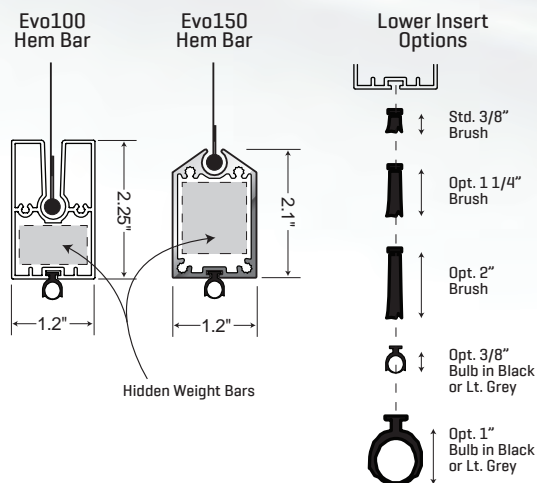

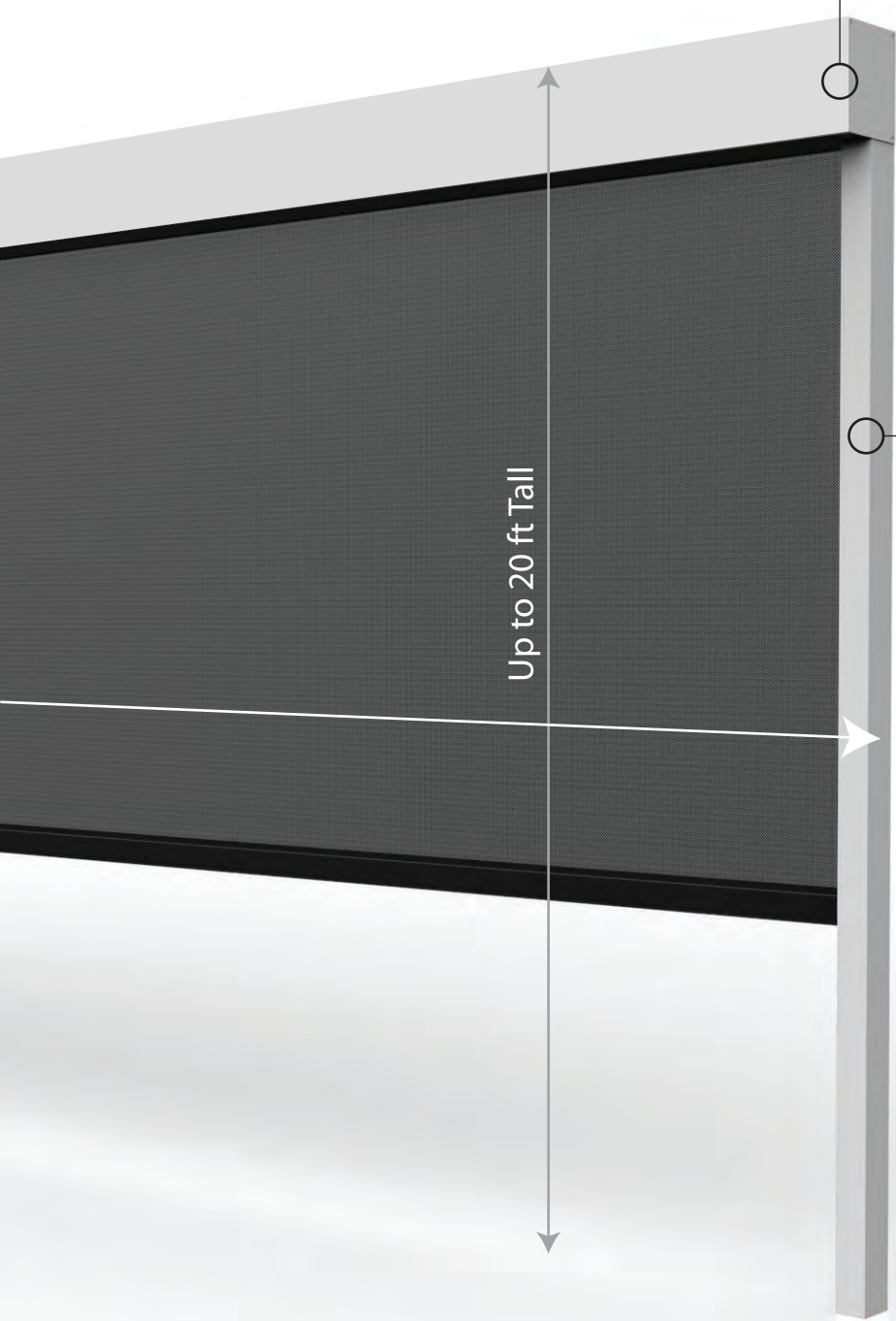

### Engineered Tubes

A specially designed roller tube allows the fabric to roll up uniformly, preventing horizontal creases. Our steel tubes are completely smooth as they are butt welded rather than folded and riveted

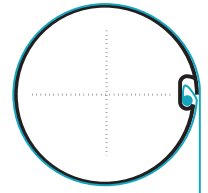

### Standard ZipTrack Side Channels

A specially engineered side channel system that locks the fabric in a track. Our ZipTrack channels are patented with an extra slippery CPVC inner guide rail that practically eliminates the possibility of shade binding or "racking". At only 1.4"x1.9" these tracks are of the lowest profile in the industry, allowing for easy recessed or surface mount universal installation. A cavity within the side channels is designed to hide the motor cable.



### Optional Wire Guides

For applications where zip tracks aren't viable we offer wire guide side retention with heavy gauge air craft cabling and stainless steel universal hold down brackets.

### In House Powder Coating

Crown has added in-house powder coating to their facility to better control the color range, quality and lead times. 20 RAL colors and 2 finishes are standard however custom colors are readily available.

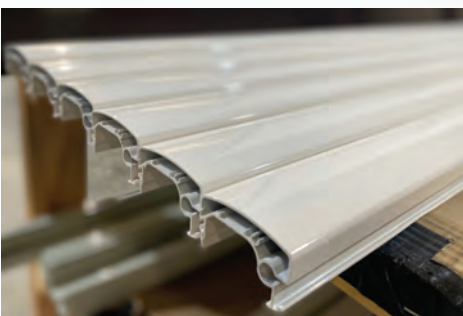

## Renson By Crown Exterior ZipShades

# RESULTS-DRIVEN TECHNOLOGY & DEVELOPMENT

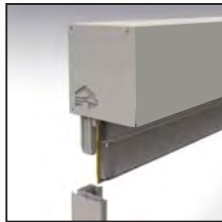

Side Channel Alignment

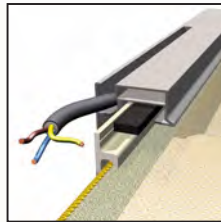

Side Channel Wire Cavity

### Compact Rail Design

Is engineered to be universally mounted in any direction - jamb, surface or recessed.

### Durable PVC Inner Guide

Fitted with a patented co-molded extra slippery inner surface requiring no added lubrication.

### Symmetrical Zipper

Ensures a high wind resistance.

## New Safety Technology

# STANDARD OBSTACLE DETECTION SYSTEM



The all new obstacle detection feature recognizes a disruption within its limits and immediately rewinds a set distance and stops. This avoids unpleasant and unforeseen situations. In addition, the detection system can differentiate between a gust of wind and a physical obstacle in its path.

## Controlling Your Shade

# Simple And Convenient Operation



You have multiple options for controlling your motorized shades. You may opt for a simple hand held remote, a wireless or wired wall switch or even a smart device app. The app allows you to create a schedule of times for your shades to move or gives you the ability to control them when you are off site. One of the most important accessories for any exterior shading product is the available wind sensor or wind and sun sensor kits. This accessory can be set to retract your shades when the wind increases to a certain level, or other pre-set weather parameters occur.



### Standard Evo Models: 100 & 150

The standard head box design which allows for the fabric roller to be loaded from the front is available in 2 profiles:

#### 100

Max. Size "Widest": 157.5"W x 106.25"H  
 Max. Size "Tallest": 118"W x 138"H

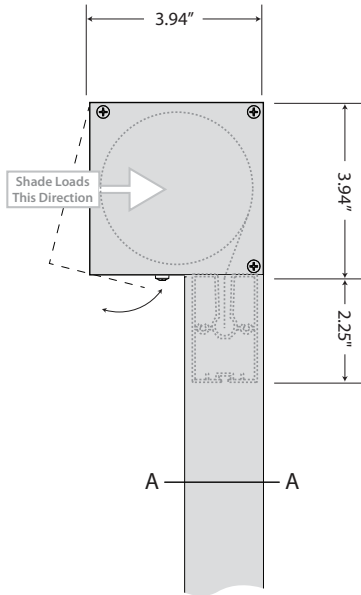

#### 150

Max. Size "Widest": 236.25"W x 133.75"H  
 Max. Size "Tallest": 126"W x 236"H

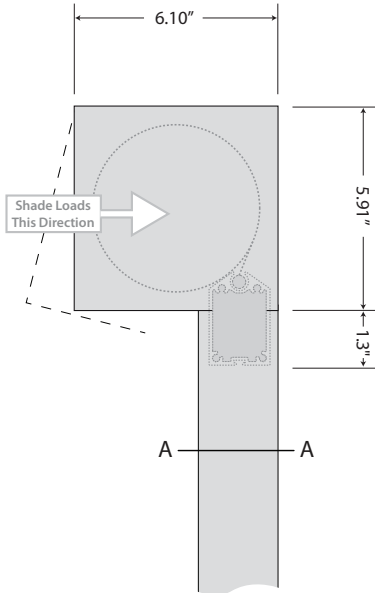

### Open Roll Model: Veue

Open roll brackets are universal and can be mounted up, side ways or back. They are ideal for site built soffits

#### VEUE

Max. Size "Widest": 240"W x 130"H  
 Max. Size "Tallest": 126"W x 240"H

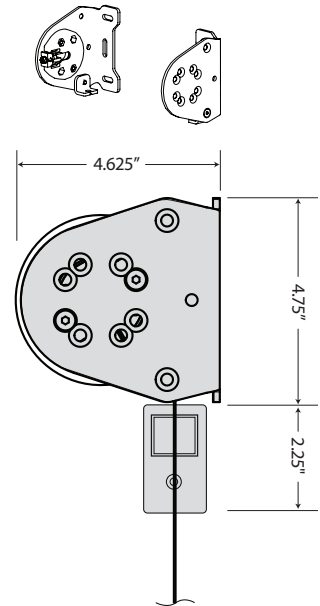

### Recessed Evo Models: 100 Slim & 150 IM7

The recessed head box is a unique housing design that allows for bottom loading of the fabric roller. For applications where a truly disappearing shade is desired this model is ideal. The fully enclosed pocket is designed to be installed in a hidden cavity or soffit. The pocket is of a 3 piece design with a removable panel for installation and servicing.

#### 100 Slim

Max. Size: 177"W x 138"H

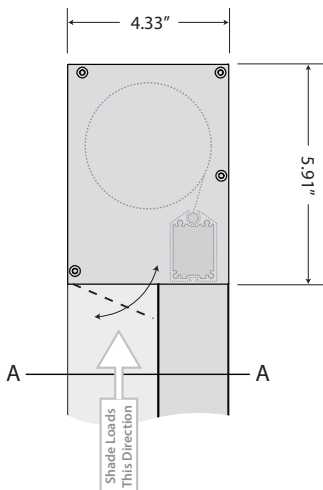

#### 150 IM7

Max. Size "Widest": 236.25"W x 133.75"H  
 Max. Size "Tallest": 126"W x 236"H

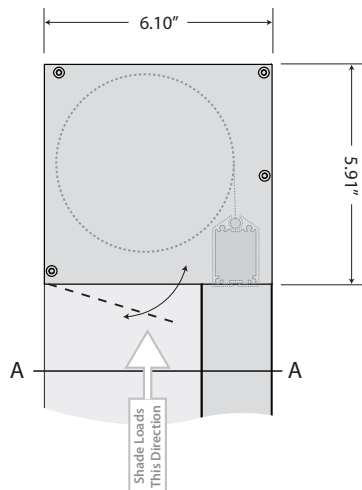

Wire Guides are optional on all models

#### Section A:A

STD Side Channel:

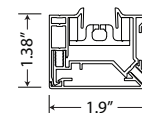

Full Depth 100 Slim Side Channel:

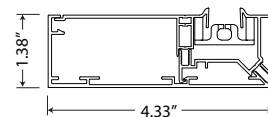

Full Depth 150 IM7 Side Channel:

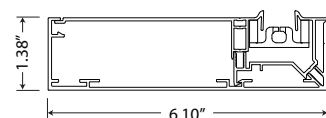



## Exterior Tension Shade Systems / CTS & CTS-L Tension Shades

Crown has partnered with European suppliers to locally fabricate 2 incredibly robust, high quality tensioned shade products for interior & exterior applications: CTS & CTS-L feature a revolutionary tension technology that integrates the proven ZipShade side retention for exceptional fabric tension regardless of installation angle.

### CTS

Max. Dimensions: Up to 157.5" wide x 118" projection  
 Design: Concealed hardware for a flush appearance  
 Fabric Offering: Soltis 88, 92, B92, Satine, Natte, E-Screen  
 Exposed Frame/Hem: Custom powder coating per order is standard  
 Motor Options: AC powered motors. Low voltage & solar powered available for CTS's under 64 sq.ft.

### CTS-L

Max. Dimensions: Up to 192" wide x 192" projection  
 Design: Concealed hardware for a flush appearance  
 Fabric Offering: Soltis 88, 92, B92, Satine, Natte, E-Screen  
 Exposed Frame/Hem: Custom powder coating per order is standard  
 Motor Options: AC powered motors

### CTS

Compact 4"x4.125" head box

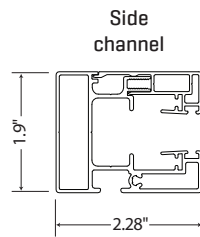
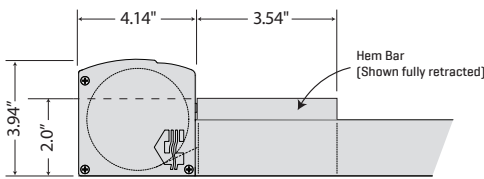

Fabric zipped in to side channels

Optional Stand-Off Feet

All tension is achieved within hem bar/head box to allow for an open 4th side

### CTS-L

5.125"x5" head box

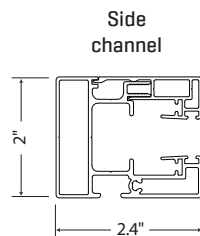
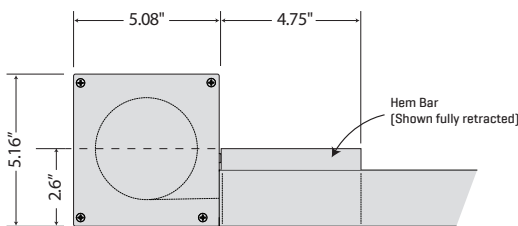

### Unique Feature!

CTS & CTS-L can be installed in a side ways orientation up to a 45 degree angle!

Up to 45°

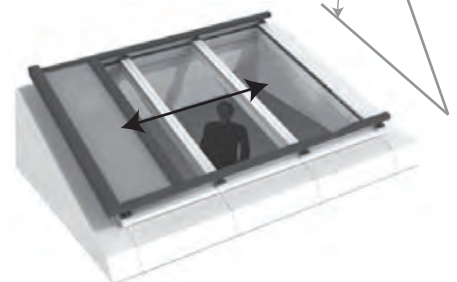

## Panoview Ultra-Wide Zip Shade

Crown has engineered the worlds first coupled shade system with zero light gaps and no center tracks. Designed for ultra-wide spans up to 60 feet the **Panoview** operates with 1 motor and ships in sections for ease of handling and installation.

### Details

- Max. Dimensions: **Each side can be up to 720" wide x 144" tall**
- Design: **Patent-Pending Coupled-Zipping System**
- Fabric Offering: **Soltis 88, 92, Satine, Natte**
- Head Box Options: **Panoview works with Evo 150 or 150 IM7 [See pg7]**
- Exposed Frame/Hem: **Custom powder coating per order is standard**
- Motor Options: **AC powered motors**



## Panovista 90 Degree Corner Zip Shade

Crown has partnered with Renson to offer the industry's only corner shade solution - the **Panovista**. This system consists of 2 shade bands positioned at a 90 degree angle with a bevel gear coupling device (thus 1 motor runs both bands). The shade bands are zipped together to provide the only ZERO light gap corner shade on the market!

### Details

- Max. Dimensions: **Each side can be up to 236" wide x 134" tall**
- Design: **Patented 90 Degree Corner Zipping System**
- Fabric Offering: **Soltis 88, 92, B92, Satine, Natte**
- Head Box Options: **Panovista solely works with 150 IM7 [See pg7]**
- Exposed Frame/Hem: **Custom powder coating per order is standard**
- Motor Options: **AC powered motors**

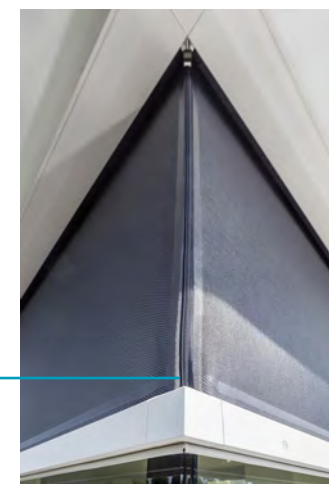
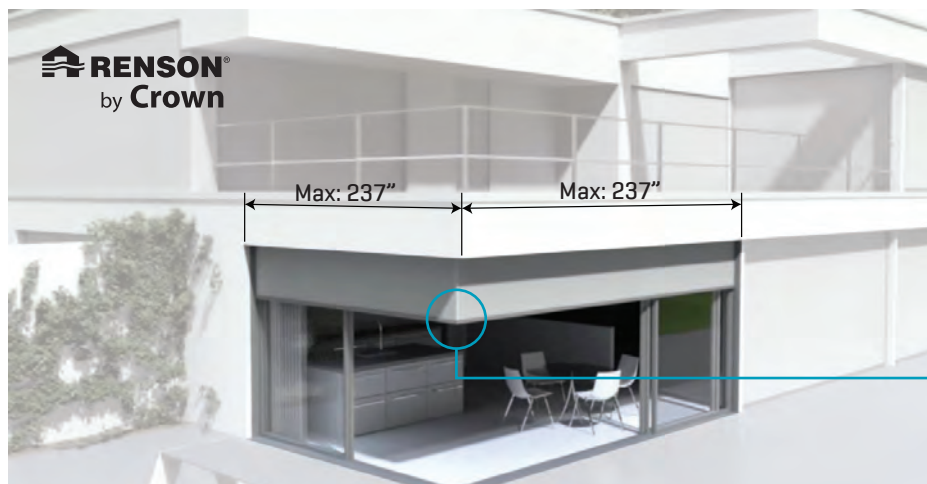



PHIFER

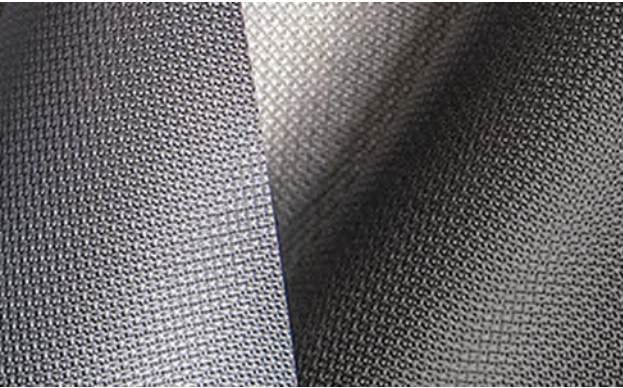

## Screens

Our expansive line of solar screen fabrics range from 1% to 45% openness and are from the largest screen weavers in the industry. They offer dimensional stability along with thermal & UV protection.

### Insect Mesh:

Simply keeps the bugs out

Examples:

- Phifer Tuffscreen
- Phifer No-See-Um

### Solar Mesh:

UV Ray/wind & insect protection

Examples:

- Mermet Satine & Natte
- Phifer Suntex
- Serge Ferrari Soltis and VeoZip



## Crystal Screens

UV stable clear vinyl crystal windows are great for providing clear exterior view throughs while allowing you to control the temperature within the living space. Crystal windows can not exceed 68" in one direction and also require a top and bottom border (typically Serge Ferrari Preconstraint 502) for durability.

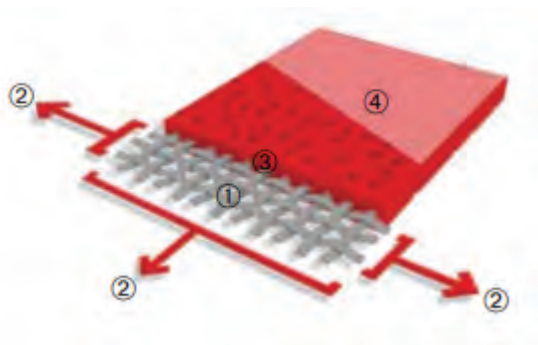
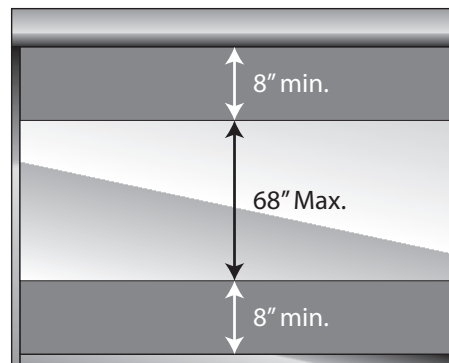

## Waterproof Fabrics

Featuring a proprietary clear coating, Serge Ferrari W-Series waterproof fabrics provide a membrane that protects against water infiltration. Offered in a variety of color choices, this material is also translucent, allowing for light emittance while drastically reducing uncomfortable solar gain.

# Learn More

---

## Online Resources:



Drawings



Wiring Diagrams



Installation  
Instructions



Quoting



Ordering

---

## Warranty Information:

### Provider of this Warranty:

Crown Shade Company provides this warranty to its dealers and distributors who were the original purchasers of the product.

### Warranty Period:

The warranty period begins on the date that the product is completed and ready to ship from the Crown warehouse.

### Crown's Responsibilities Under this Warranty:

Crown Shade Company, warrants to the original purchaser that the product manufactured by Crown is free from defects in material and workmanship under normal use and as long as the product remains in the original window. Crown Shade's obligation under this warranty shall be limited to the repair or exchange of any parts or components that may prove defective in normal use. Crown Shade Company reserves the right to inspect any product or component prior to repair, replacement or refunding of the purchase price. Field labor and shipping costs to and from Crown is not included.

### Provisions and Limitations:

This warranty shall not apply to any of the parts that have failed due to accident, negligence, alterations, misuse, abuse, improper handling, installation or maintenance. Failure to follow instructions for operating or installing the product, loss of color intensity due to UV exposure over an extended period of time, or normal wear and tear will also void this warranty. Shade installations that are intensively exposed to damaging weather conditions are also void from this warranty. Crystal screen clear vinyl shade panels are not warranted. Field labor and shipping costs to and from Crown is not included.

To obtain service under this warranty, contact Crown Shade Company at 1-410-682-4450, [sales@crownsnadeco.com](mailto:sales@crownsnadeco.com) or return the product to 775 Chesaco Avenue | Baltimore, Maryland | 21237 . The original purchaser shall be responsible for the transportation cost of the product to Crown Shade Company. Crown will pay for shipping the product or replacement back to the original purchaser anywhere in the continental United States.



**Crown Shade Company**

[crownshade.com](http://crownshade.com) / 800-445-5557 / 775 chesaco ave - baltimore, maryland 21237

csc\_crss\_7/2022